



# Tower 2024

Division B and C

September 2023 to May 2024

Greg Marconnet

Chuck Stachovic

Questions/Comments? Write [gmarconnet@gmail.com](mailto:gmarconnet@gmail.com)

# So, what kind of Structures are WE talking about?

Real World Towers

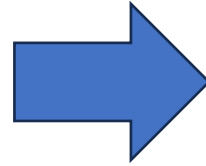

Science Olympiad Towers

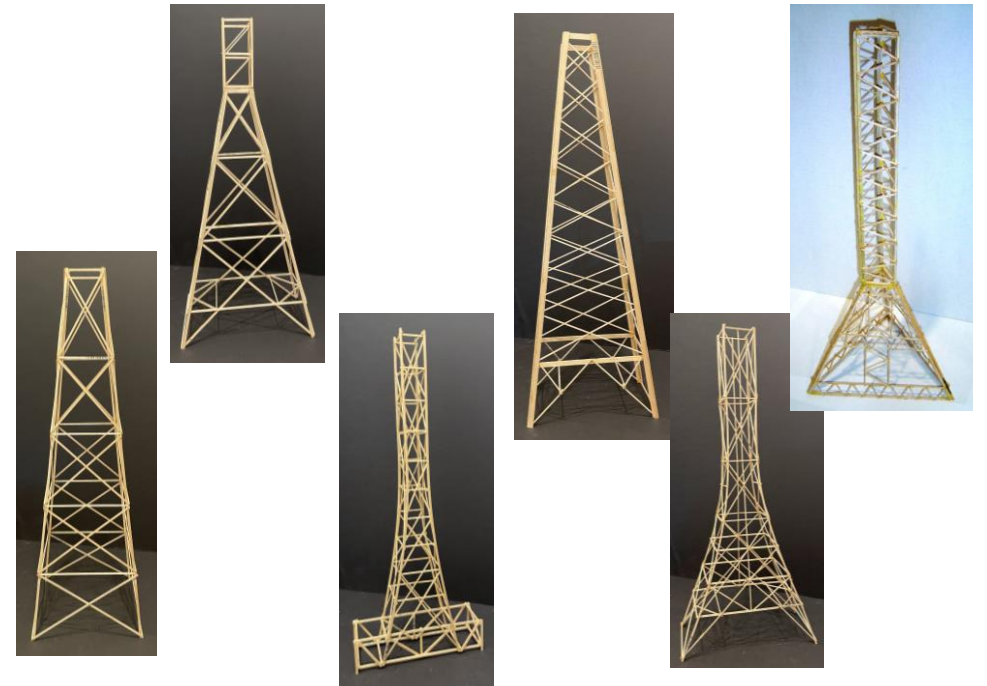

**NOTE: Examples May Not meet the 2024 Tower Requirements**



# Tower Objective

## Design and build a tower to achieve the highest structural efficiency

- Structural Efficiency (SE) is a measure of how a design and its construction performs in relationship to its mass
- $SE = \text{mass held by tower} / \text{mass of tower}$
- **Bonus** can be obtained by designing the Tower to span a 29 cm diameter circle and/or completing a design log (Div. C).

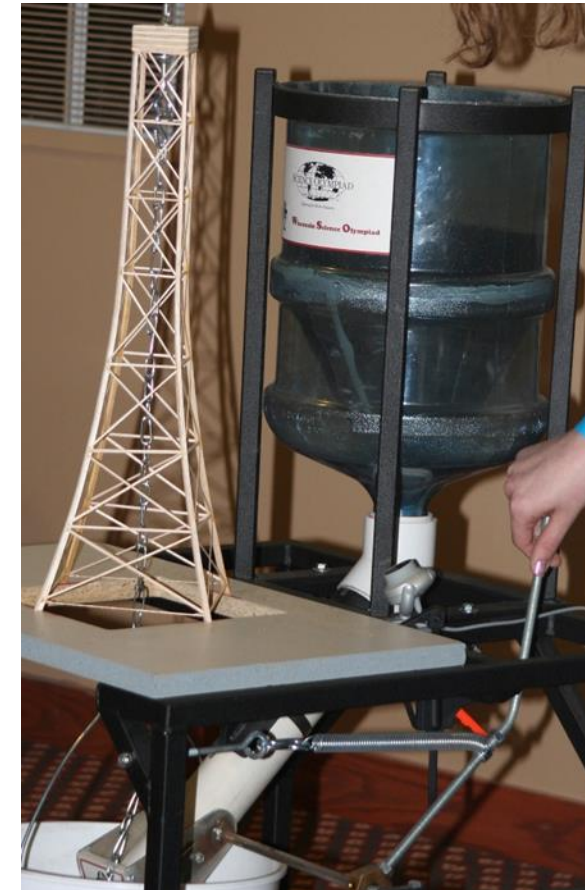

# KEY Rules Review

The purpose of the following section is to help you better understand the rules, but this section does not replace the rules!

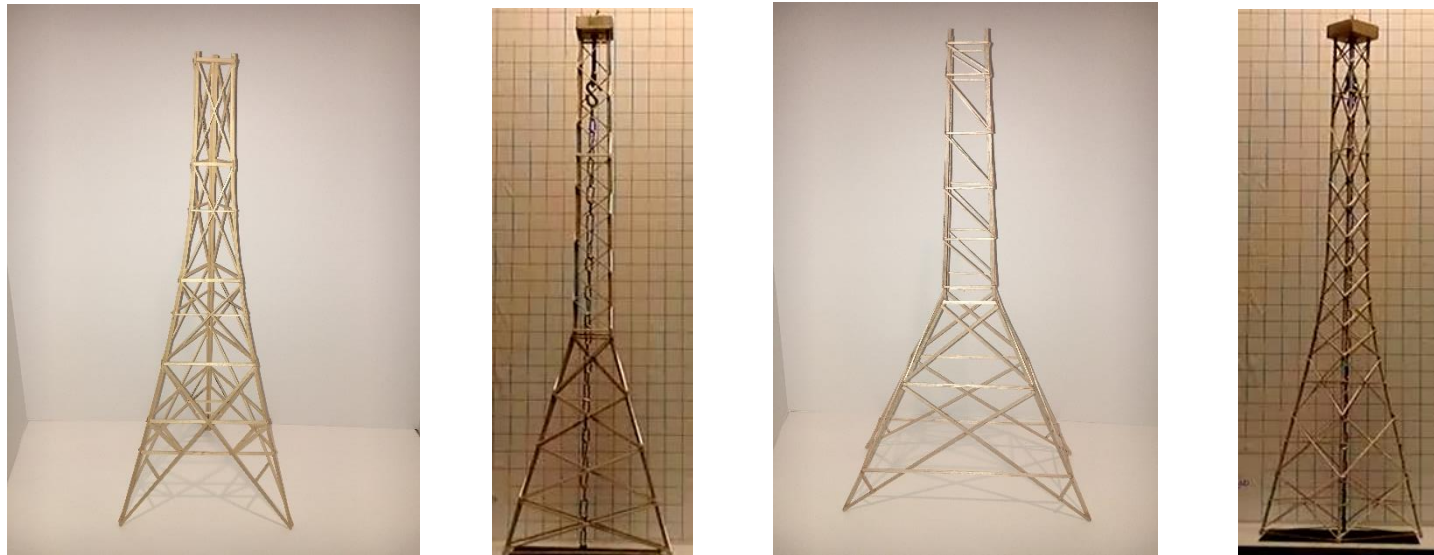

In previous state competitions, 19% of the structures did not meet the building rules!

## 2. Event Parameters

---

- a. Each team is allowed to enter only **one Tower built prior to the competition.**
  - b. Team members must wear **proper eye protection** [category B] during the set-up and testing of the Bridge. Teams without eye protection must not test and must be ranked in Tier 3.
  - d. The **Event Supervisor will provide all Test Apparatus**
-

# Eye Protection Policy

Excerpt from July 29, 2015 update.

- **CATEGORY B**

- Impact protection. They provide protection from a high inertia particle hazard (high mass or velocity)
- ANSI designation/required marking: **Z87+**
- Note: Prescription glasses must bear the "Z87+" mark to be used
- Web link: [http://www.soinc.org/eye\\_protection](http://www.soinc.org/eye_protection)

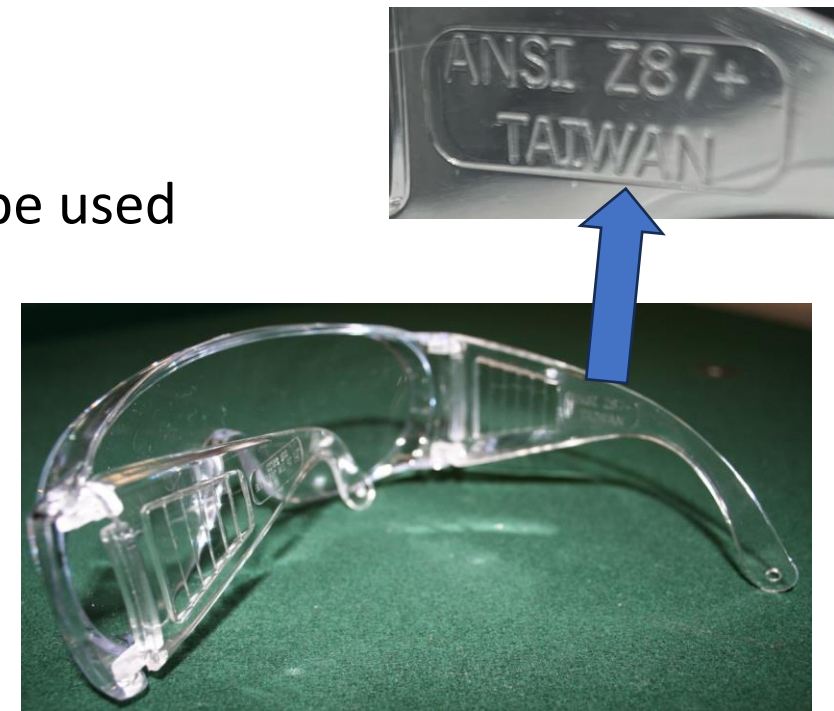

### 3. Construction Parameters

---

a. The Tower must be a **single structure**, with no separate or detachable pieces, constructed of wood and bonded by adhesive. No other materials are permitted.

i. **Wood** is defined as the hard-fibrous substance making up the greater part of the stems, branches, trunks, and roots of trees beneath the bark. Wood does NOT include bark, particleboard, wood composites, bamboo or grasses, paper, commercial plywood, members formed of sawdust and adhesive. Wood may never be painted, color enhanced, or have preprinted/paper labels affixed. Ink barcodes or markings from the construction process may be left on wood.

ii. There are **no limits on the cross-sectional sizes** of individual pieces of wood. Wood may be laminated without restriction by the team.

iii. **Adhesive** is defined as a substance used to join two or more materials together. Any commercially available adhesive may be used. Adhesives include, but are not limited to: glue, cement, cyanoacrylate, epoxy, hot melt, polyurethane and super glues. Adhesive tapes are not allowed.

### 3. Construction Parameters

---

b. The **Structure must span a 20 cm x 20 cm opening** on a Test Base (6.a.) and may be placed on the Test Base surface in any configuration such that the **loading chain is suspended within 2.5 cm of the center of the opening in the Test Base**. Bonus Points (7.c.) can be obtained by designing the Tower to span a **29-cm diameter circle**, centered on the 20 cm x 20 cm opening of the Test Base and hold 15 kg.

---

c. The Tower must **support the Loading Block** (6.b.i.) a minimum of 50.0 cm (Division B) or 60.0 cm (Division C) above the Test Base. There is no maximum Tower height.

---



# Test Base

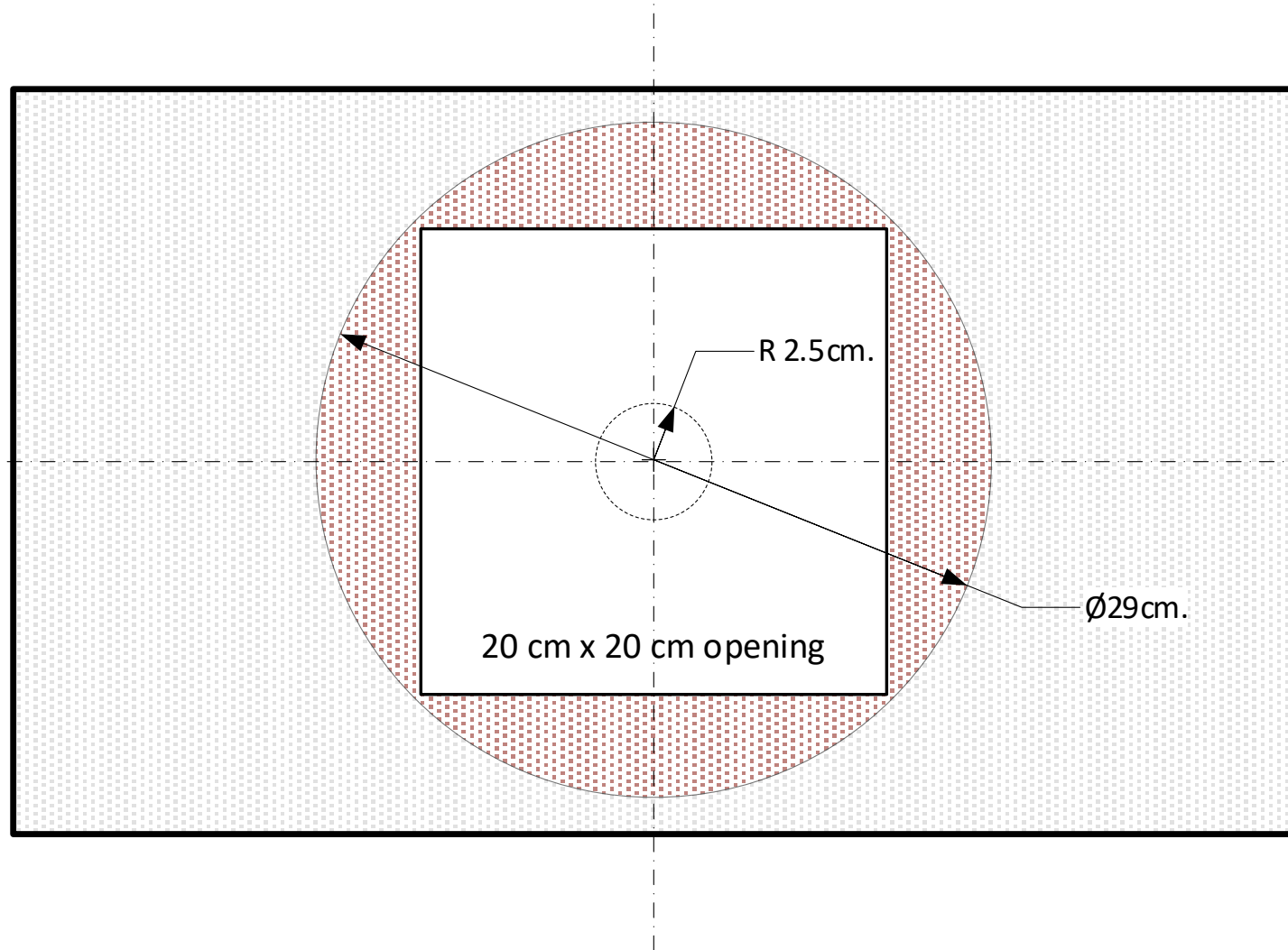

- Minimum 55cm X 32cm smooth, hard, solid, level, mounting surface
- 20cm X 20cm centered cut-out
- Marking of a 29cm diameter BONUS circle

# Mounting Options

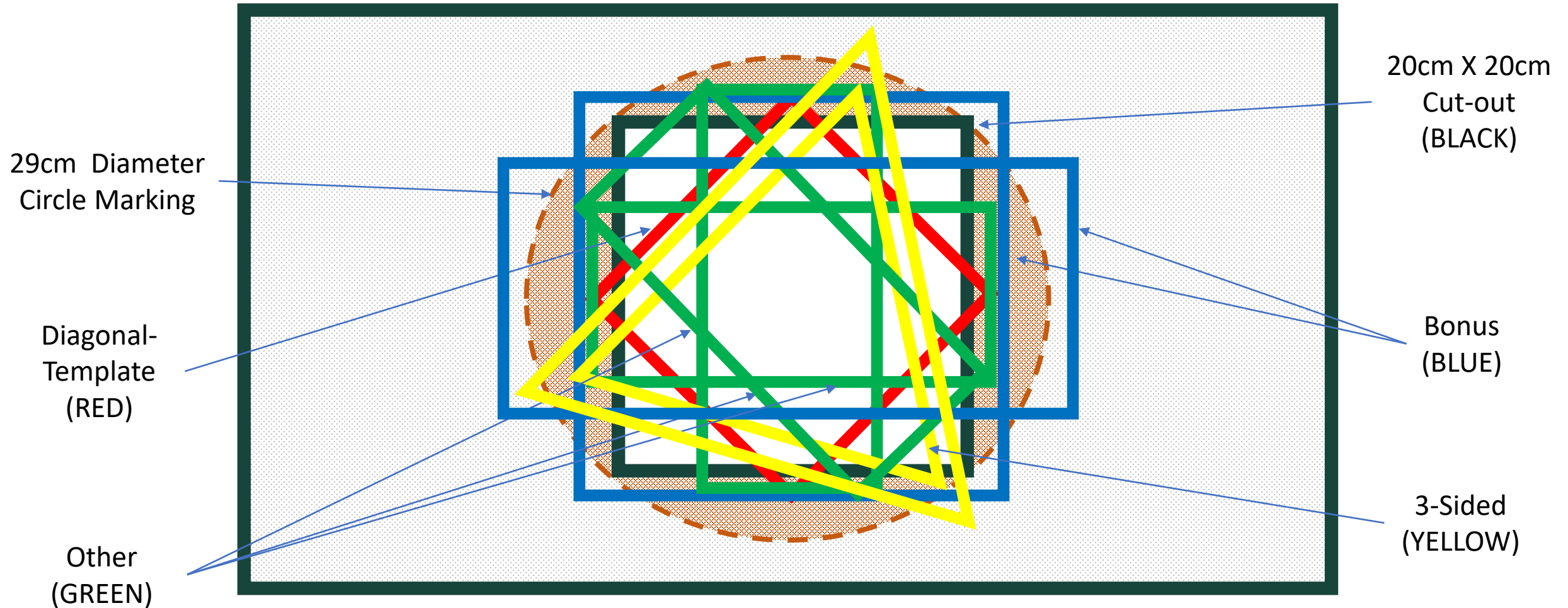

# 3. Construction Parameters

e. Participants must be able to answer Questions regarding design, construction and operation per policy.

## Building and Tools Policy - CONSTRUCTED DEVICES

Amended July 20, 2008 - Original Adoption 1986

- The **process of design and resultant product is the students' responsibility**. All components must be made by the student or, if permissible by the event rules, available by purchase. Students will assemble the device.
- **Safety shall be of paramount importance**. Students will be encouraged to use tools and technology within their age-related safety range. The use of chemicals should also follow age-appropriate use rules.
- **Adults may act as facilitators** in the building process by asking questions, offering ideas or suggestions and providing references.
- **Event supervisors may extensively question the lead student as to the design and construction of the device.**
- **If the students on the device team cannot answer the questions correctly and/or the coach cannot verify the device was student-built, then the Event Supervisors have grounds to believe the students did not design and build the device. The team will be disqualified from the event and scored accordingly.**

[https://www.soinc.org/building\\_tools\\_policy](https://www.soinc.org/building_tools_policy)

# 4. Design Log

- Not required, Division C bonus.
- Must use template in rules.
- One log for each tower.
- Minimum number of unique structures logged:
  - Invitational: 1
  - Regional: 2
  - State: 3
  - National: 4

Design Log		
School: <b>ABC Middle School</b>	Team: <b>Bxx - Waterdogs</b>	Students: <b>John Doe &amp; Jill Doe</b>
Design Name/Number: <b>2<sup>nd</sup> Tower Build</b>		<b>Jill Doe</b>
Requirement	Team Notes	Event Supervisor Comment
Sketch of design	<ul style="list-style-type: none"> <li>• Add <u>hand</u> or CAD drawing to the back of this form or attach a separate sheet.</li> <li>• Include key dimensions, angles, size of structure members, name of student(s) and date.</li> </ul>	
Materials used List materials used and why you chose these materials	<p><b>Balsawood – Lightest, yet strong. Still using SO Template but decreased the member size to next smaller increment (vertical member is now 1/8"x1/8", and cross support members are 3/16"x 3/16"). Also, will use an "X" to increase support.</b></p> <p><b>Glue: Cyanoacrylate Gap Filling 5-10sec cure</b></p>	
Predictions load held, weak points	<p><b>Last bridge (Template design) held full load, so my 2<sup>nd</sup> Tower is much lighter, and I'd hope that it would fail near the full load, so that I can see that my design change (lighter) still was strong.</b></p>	
Date of Test	<b>June 03, 2023</b>	
Weight before testing in grams	<b>13.04gms, or a reduction of 7.44gms (Template Tower was 20.48gms)</b>	
Test results load held, breaking points	<p><b>Load Held = 15,000gms – FULL LOAD!</b></p> <p><b>Structural Efficiency = 15,000gm / 13.04gm = 1150.3 <u>Score</u> (Template score was 732 Tier 1, so increased score by ~500!)</b></p> <p><b>Breaking Points: NONE! (Over designed!)</b></p>	
Observations What did you learn from the construction and testing of the Structure?	<p><b>More difficult to level legs and get the Load Block to be level as the top support dimension was slightly oversized.</b></p> <p><b>No movement by any members (bending due to compression).</b></p> <p><b>No sounds of bonds cracking.</b></p>	
Design Improvements What will you do differently on the next structure?	<p><b>Decrease the length of the top members so that load block is better supported, and easier to align. – EASE OF PROCESS</b></p> <p><b>Remove adjacent X supports, and stagger the supports so that two layers have 3 "X" supports, and other adjacent sides have only 2. – DECREASE MASS</b></p> <p><b>Carefully match the density of each of the 4 vertical members; select lower mass matched members for vertical legs – DECREASE MASS</b></p>	

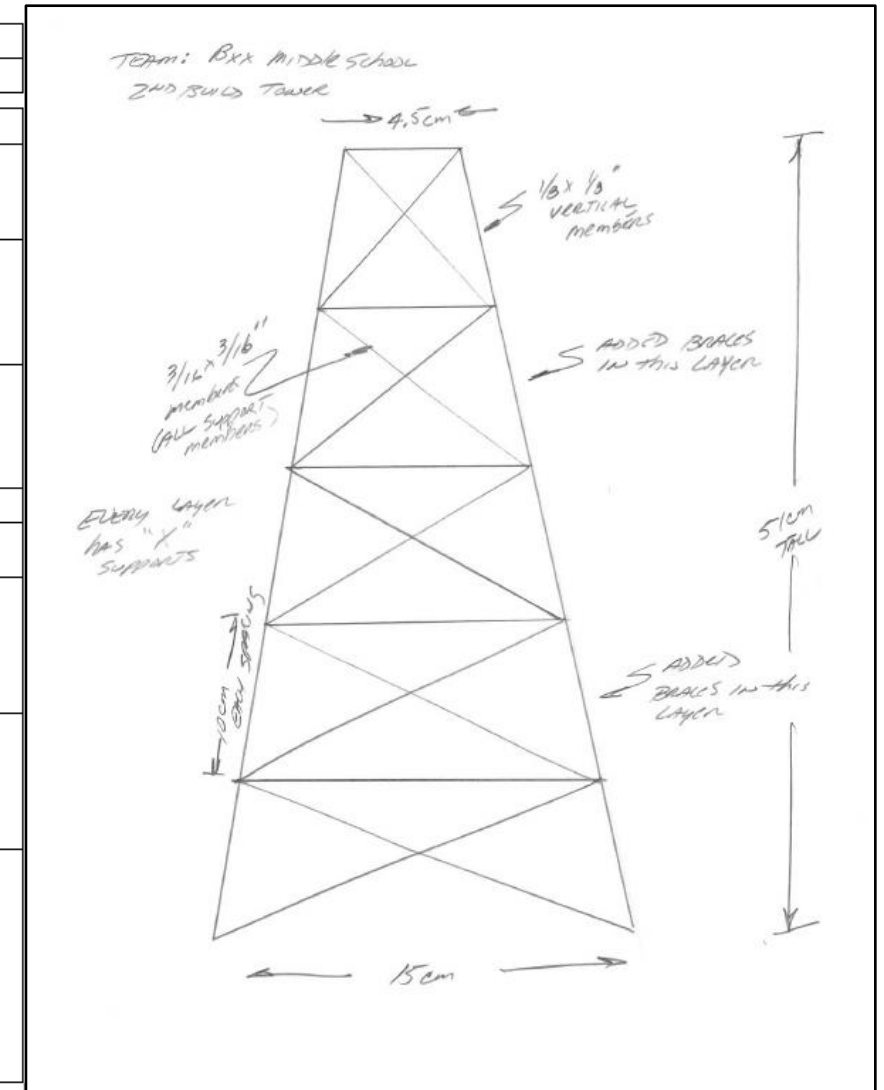



# 5.Part I & II: Check-in & Test

- **TEAM:** Bring Structure, Design Log, Estimated Load Supported, Event Slip, and Eye Protection to event at designated time.
- **TEAM:** measure Structure Mass and Height with Supervisor
- **SUPERVISOR:** Evaluate Structure for compliance to rules. Review Design Log (*Div C only*) & return.
- **TEAM:** Test Structure in 6 minutes or less by mounting to Stand, attach Loading Assembly and load Sand until failure, max. load or time expires.
- **SUPERVISOR:** Monitor testing, measure Load Supported, determine bonus, calculate score and Tier.
- **SUPERVISOR:** Complete check in list, review with TEAM. Structure is returned to TEAM.



**Tower 2024**  
Based on 2024 Rules and Clarifications  
as of 23 September 2023



Division \_\_\_\_\_ Team Number \_\_\_\_\_ Team Name \_\_\_\_\_ Time Slot \_\_\_\_\_

Student Names (up to 2): \_\_\_\_\_

1. Did you and/or a team member design and build the Bridge being tested? Yes \_\_\_ No \_\_\_

5.L.f Load Supported Estimate (loading block assembly, bucket, sand) May not exceed 15,000 g \_\_\_\_\_ g

STUDENTS – DO NOT WRITE BELOW THIS LINE			
Competition Check-In			
4., 5.L.a	<b>Log Book (Div. C ONLY):</b> documentation of Structures tested prior to competition. MINIMUM Structures documented: Invitational: 1; Regional: 2, State: 3 or more; National: 4. C = Complete, I = Incomplete/No Log	C / I	
3.e	<b>Design Knowledge:</b> Answer questions on design, construction & operation	T/F	
1, 2, b	<b>Eye Protection B,</b> Protective eyewear must be worn, required ANSI marking: Z87+ (F = Tier 3)	T/F	
3.a	<b>Construction:</b> Single Structure, no separate, lose or separate parts, constructed of wood, bonded by adhesive	T/F	
3.c, 5.I.c	<b>Supports loading block</b> at a minimum 50.0 cm (Division B) or 60 cm (Division C) above test base	CM	
5.L.h	<b>Tower Mass</b>	0.01 gram	
Competition Testing (6 Minutes)			
5.II.c, 5.II.d	<b>Teams set up</b> Tower on test base. <b>Structure is not adjusted</b> once loading of sand has begun	T/F	
3.b, 5.II.e	<b>Spans opening</b> of 20 cm x 20 cm and loading chain within 2.5 cm of opening center	T/F	
3.d	Only the <b>Loading Block</b> (6.b.i.) supports chain and bucket.	T/F	
5.II.e	<b>No alterations, substitutions, or repairs</b> made after check-in process has started	T/F	
5.II.a	<b>Team did not leave</b> event area after check-in or gain outside assistance, materials, or communication	T/F	
5.II.g	Direct contact of bucket is <b>only by stabilizing sticks</b>	T/F	
5.II.h	<b>Test completed</b> in 6 minutes or less.	T/F	
5.II.i	<b>Minimum load supported</b> is the mass of the Loading Assembly (6.b.v)	T/F	
5.II.j	<b>Load Supported</b> (grams to the nearest gram) may not exceed 15,000 g. Minimum load supported is the mass of the Loading Assembly (6.b.v)	grams	
Scoring			
7.c; 3.b, 5.II.f	<b>Load Scored Bonus:</b> holding 15,000 grams & span 29cm circle (Bonus = 5,000 g)	grams	
7.b	<b>Load Scored</b> (Load Supported + Load Scored Bonus)	grams	
7.d	<b>Log Book Multiplier:</b> Division B = 1.0; Division C: Complete = 1.25; Incomplete/Noncompliant/no log = 1.0	unitless	
7.a	<b>Score</b> [(Load Scored)/ Tower Mass] * Log Book Multiplier	unitless	
7.e	<b>Tier 1,</b> meeting construction and competition, and requirement <b>Tier 2,</b> NOT meeting construction, competition requirements <b>Tier 3,</b> Unable to support load, no eye protection	1, 2, or 3	

5.II.h: Failure is defined as the inability of the tower to carry additional load; any part of the load is supported by anything other than the tower

7.f. Ties broken as follows: 1. Estimated Load Supported closest to, without exceeding, the actual Load Supported, 2. Lowest Structure mass.

2.c. Participants may not bring any equipments!

# 5.Part II: Testing

---

- a. Once participants enter the event area to compete, they **must not leave or receive outside assistance**, materials, or communication until they are finished competing.
  - b. Participants will have **6 minutes** to setup and test their Tower to maximum load or failure.
  - c. The **participants must place the Tower** on the Test Base and assemble the Loading Block Assembly and bucket as required to load the Tower. If necessary, participants may disassemble the Loading Block Assembly. The bucket must be mounted to allow enough clearance above the floor for the bucket to tilt or the Tower to deflect.
-

## 5.Part II: Testing

- 
- d. The participants will be allowed to **adjust the Structure until they start loading sand**. Once loading of sand has begun, the Structure must not be further adjusted.
- 
- e. The event supervisor will check the loading chain is suspended within 2.5 cm of the center of the opening in the test base before loading begins.
- 
- f. The event supervisor before testing will verify that no part of the Tower's span touches or is supported within the 29.0 cm diameter circle for the Tower to qualify for the "**Load Scored Bonus**".
- 
- g. Participants will load the sand into the bucket and be allowed to safely and effectively stabilize the bucket from movement caused by sand loading. Direct **contact with the bucket by participants is NOT allowed**. Teams choosing to stabilize the bucket must only use the tips of the bucket stabilization sticks (6.d.).
-

# 5.Part II: Testing

---

- h. **Loading stops** immediately when a failure occurs or when time expires. Structural Failure is defined as the inability of the structure to carry any additional load, or any part of the load being supported by anything other than the structure. Incidental contact by the chain/eyebolt with the structure is not failure.
- k. The supervisor will review with the team the data recorded on their scoresheet.





# Manual Load Test Apparatus

- A. Stand with level adjustments
- B. Load Block With Eye-Bolt & Wing-nut
- C. Chain with S-Hook
- D. Load Bucket With S-Hook
- E. Scoop Bucket (With 15kg Of Pre-weighed Sand)
- F. Stabilization Sticks (X 2)
- G. Scoop Cans (Various Sizes)
- H. Bucket Scale (0-25000gm)
- I. Structure Scale (0-200.00gm)
- J. Ruler (up to 60cm)
- K. Count Down Timer

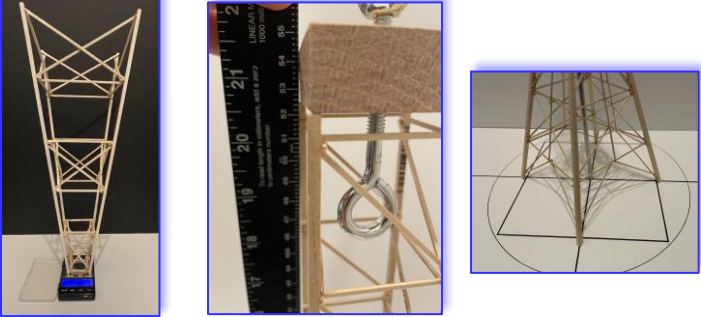

**For In-Person Competitions, Supervisor Will Provide Event Testing Equipment**

# 5.Part II: Competition Testing: Manual Load

 <p>1) Check-in by Student: a) Discusses design/construction &amp; estimated Load; b) Structure Weighed; c) Height is verified, d) Determine if Bonus is pursued</p>	 <p>2) Timer Starts: a) Mount Structure to Stand, then b) Mount Load Block Assembly; then c) Attach Empty Bucket</p>	 <p>3) Supervisor Visually Verifies Mounting setup &amp; Structure holds Minimum Load</p>
---	--	--

	<p>4) <b>CAREFULLY</b> Start pouring Sand from storage bucket into the Load bucket. Use the Stabilization Sticks to stop bucket from swaying (if necessary). Stop at 6 minutes, or at Full Load, or When ...<sup>18</sup></p> <p><b>STRUCTURE BREAKS !</b></p>	 <p>5) Confirm Load Held (15kg max: Bucket, Load Block Assembly; Chain, and Sand); Sand is returned to Hopper</p>
--	--	---

# 5.Part II: Competition Testing: Hopper System

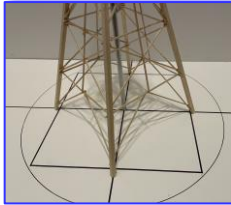
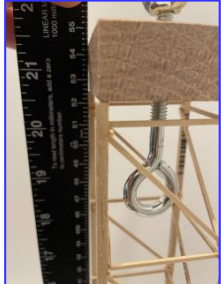

1) Check-in by Student: a) Discusses design/construction & estimated Load; b) Structure Weighed; c) Height is verified, d) Determine if Bonus is pursued

2) Timer Starts: a) Mount Structure to Stand, then b) Mount Load Block Assembly; then c) Attach Empty Bucket

3) Supervisor Visually Verifies Mounting setup & Structure holds Minimum Load

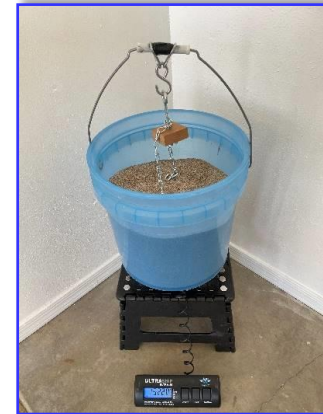
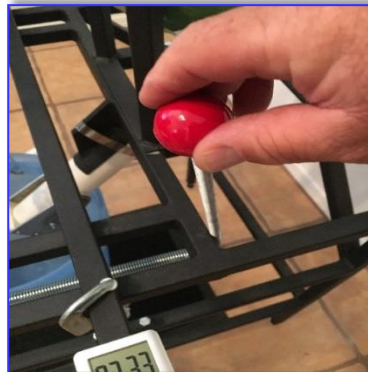

4) Ready to Start Loading the Structure

5) **CAREFULLY** Pull Lever with RED BALL to start pouring Sand from Hopper into the bucket. **STOP** at 6 minutes, or at Full Load, or When ... **STRUCTURE BREAKS !**

6) Confirm Load Held (15kg max: Bucket, Load Block Assembly; Chain, and Sand); Sand is returned to Hopper



# Test Stand Equipment

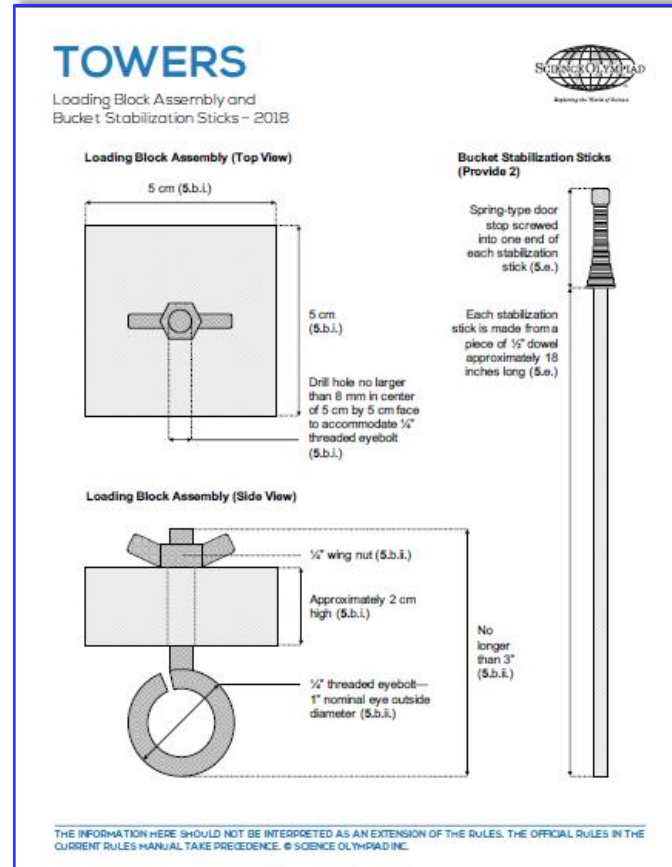
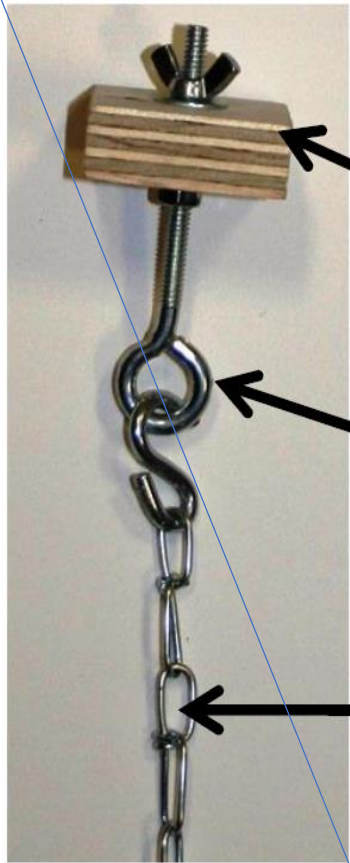

Thoroughly Read & Understand Each Requirements



# Affordable & Available Scale Options

- **Structure Scale:** Search Amazon.com for “Jeweler's Scales”

- Fusion Digital Scale 0-200g/0.01g @ ~\$9
- Gram Scale 220g/0.01g @ ~\$12
- Weigh Gram Pocket Scale 0-200g/0.01g @ ~\$8



---

- **Load Scales:** Search Amazon.com for “Postal Scales”

- Fusion Shipping Scale 86lb (or 39Kg/0.000Kg) @ ~\$24
- Amiloe Digital Postal Scale 66lb (or 30Kg/00.0Kg) @ ~\$30
- MyWeigh Ultra Ship Ultra 35/55/75 lb Scale display in grams @ <\$55



**DO NOT USE: Triple Balance Beam, Bathroom, In-Line, or Luggage scales!**

# 7. Scoring

---

a. **Score** = [Load Score (g) / Mass of Tower(g)] \* Log Multiplier. High score wins.

b. The **Load Score** = Load Supported (5.b.ix) + Load Scored Bonus (7.c)

c. **Load Scored Bonus:** Towers spanning the 29 cm diameter circle and hold 15 kg will earn a 5,000g bonus.

d. Log Multiplier

i. Division B: Log not scored, Multiplier = 1.0

ii. Division C: Compliant Log = 1.25;

Incomplete, Non-Compliant or Not Submitted = 1.0

---

# 7. Scoring

---

e. Towers will be placed in **three tiers** as follows:

- i. Tier 1: Hold any load, meeting all the Construction Parameters and no Competition Violations.
- ii. Tier 2: Hold any load, one or more Competition Violations.
- iii. Tier 3: unable to be loaded for any reason (e.g., cannot accommodate Loading Block, or failure to wear eye protection), and will be ranked by lowest mass

f. **Ties** are broken as follows: 1. Estimated Load Scored closest to, without exceeding, the actual Load Scored, 2. Lowest Tower mass

# Example Scoring

Load Score = Load Supported + Load Score Bonus

Score = [Load Score (g) / Mass of Tower(g)] \* Log Multiplier

Team	Mass of Tower	Load Supported	Structural Efficiency	Bonus	Load Score	Adjusted SE	Log Book Multiplier	Score	Tier	Rank	Comments
	grams	grams		grams	grams						
<b>A</b>	20.00	5,000	250	0	5,000	250	1.25	<b>313</b>	<b>1</b>	6	Compliant design that broke at ~third of Load, no Bonus, and had a compliant Design Log
<b>B</b>	35.00	14,000	400	0	14,000	400	1.25	<b>500</b>	<b>2</b>	8	Non-Compliant design (too short) that broke at near full Load, and had a compliant Design Log
<b>C</b>	40.00	15,000	375	5,000	20,000	500	1.25	<b>625</b>	<b>1</b>	5	Compliant design that held the full Load and received the bonus, and had a compliant Design Log
<b>D</b>	15.00	12,000	800	0	12,000	800	1.25	<b>1,000</b>	<b>1</b>	2	Compliant design that broke at majority of Load, with a compliant Design Log
<b>E</b>	30.00	15,000	500	5,000	20,000	667	1.00	<b>667</b>	<b>1</b>	4	Compliant design that held the full Load and received the bonus, but was missing elements of the Design Log
<b>F</b>	25.00	15,000	600	5,000	20,000	800	1.00	<b>800</b>	<b>1</b>	3	Compliant design that held the full Load and received the bonus, but no Design Log submitted
<b>G</b>	10.00	15,000	1,500	5,000	20,000	2,000	1.25	<b>2,500</b>	<b>2</b>	7	Non-Compliant design (too short) that held the full Load and received the bonus, and had a compliant Design Log
<b>H</b>	7.00	0	0	0	0	0	1.00	<b>0</b>	<b>3</b>	9	Compliant design that could not accommodate the Load Block
<b>I</b>	8.50	15,000	1,765	5,000	20,000	2,353	1.00	<b>2,353</b>	<b>1</b>	1	Compliant design that held the full Load and received the bonus, but was missing elements of the Design Log

**Team I Wins with highest score in Tier 1**

# What Is A Good Structural Efficiency?

$$\text{Structural Efficiency} = \text{Load Held} \div \text{Mass of Structure}$$

Structure's Mass		Load Held	Score
<b>Heavy (&gt;30 gms)</b>	<i>Initial Invitationals</i>	Very Little (1.5Kg Min)	Very Low (<50)
		Near Full Load (No Bonus)	Low (<250)
		Full Load (15Kg) & Bonus	Moderate (<600)
<b>Medium (~20 gms)</b>	<i>Various Regionals</i>	Very Little (1.5Kg Min)	Very Low (~100)
		Near Full Load (No Bonus)	Moderate (~400)
		Full Load (15Kg) & Bonus	Moderate (1000)
<b>Light (&lt;10 gms)</b>	<i>State &amp; NSO Level</i>	Very Little (1.5Kg Min)	Low (~150)
		Near Full Load (No Bonus)	High (<1500)
		Full Load (15Kg) & Bonus	Very High (>2000)

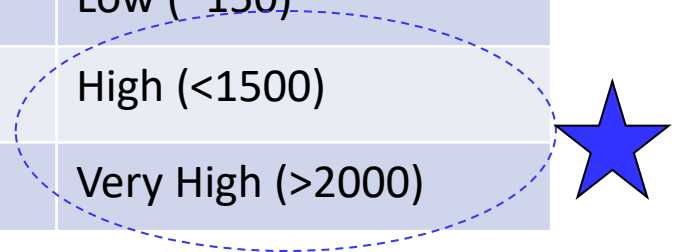

# Bonus Impact 2018 Division C National Data using 2024 Rules

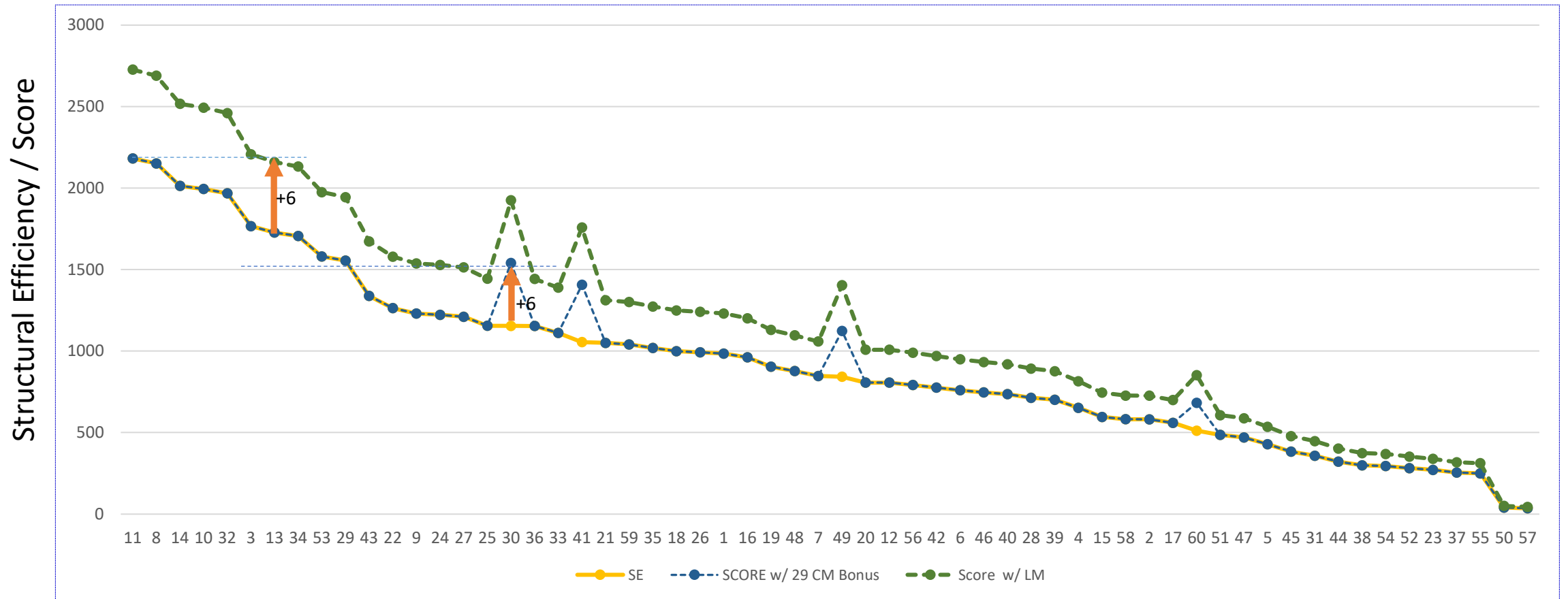



# Building & Design

- It is not the purpose of this document to provide design specifics. It is your structure, not ours! 😊
- Teams should do some research... look in books, search the internet...or just look at some structures in the world around you.
- This document will provide some thoughts about general topics related to the building and design of your Structure.
- Be creative and have fun!!

# The Scientific Process

It's All About The Discovery!

- Read the rules; Re-read the rules
- Research: books, internet...or just look at some structures.

- Talk with your Physics or TechEd teachers! They will have ideas!
- Draw a design and build

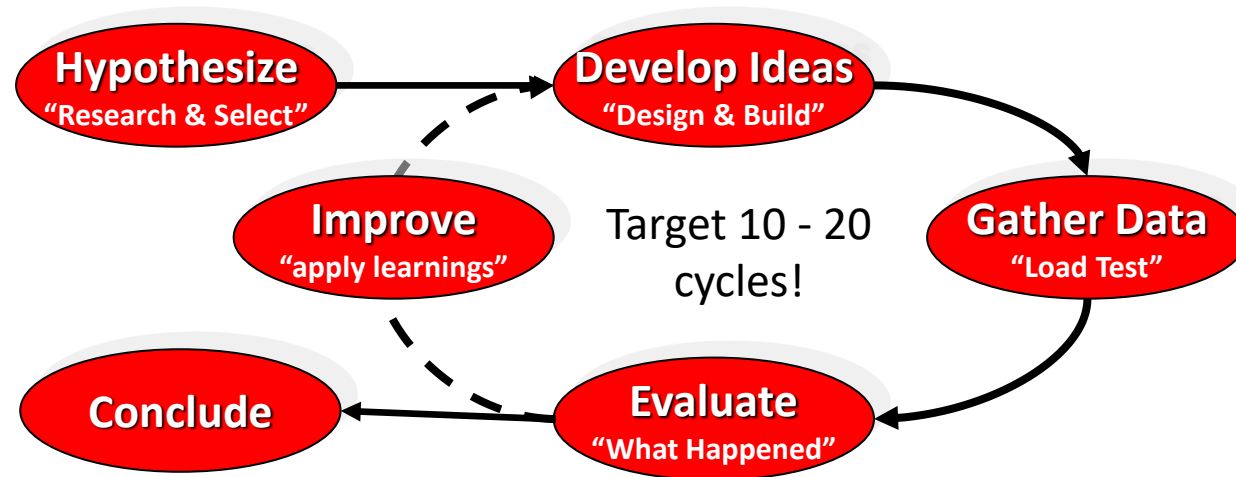

- Predict what will happen
- Model in software
- Video all tests! Review in slow motion.
- iPhones work great!

- Build an "optimized" tower

- Tower Breaks: Where did the tower break? Why?; Evaluate bonding, wood failure points

- Holds 15 Kg: Overbuilt? What members are not needed? Can wood cross section be smaller? Can design be simplified?

..... And keep a log of the process!

# What Should I Expect From This Event?

- Team will want to build and test multiple towers... 2 to 20
  - Beginners should plan for a weekend to build a good structure
  - Experts can build a structure in a few hours.
  - 1<sup>st</sup> structure build:
    - use SO Template. OK to be Heavy ~30grams.
    - Assure structure complies with all rules
  - Future Builds: Learn from failures, diagnose 1<sup>st</sup> failure mode, focus on improvements to make lighter. Reduce pieces; reduce size of wood; reduce glue ...
- No Guarantee that Structure will hold during multiple loadings (fatigue)
- Practice test set-up, sand pouring, bucket stabilization

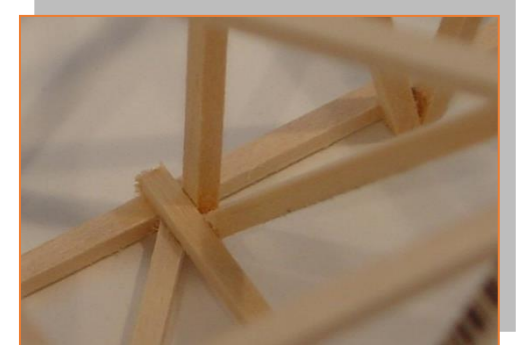

# Tower Event Challenges

## Design

- Base design & orientation
- 29cm diameter Bonus
- Compression forces and member sizing
- Tall Structure susceptibility to bucket swings
- Mitigation of warping and twisting effects
- Design to wrong division rules

## Materials

- Wood grain/density inspection
- leg pairing for equally divided load distribution
- Glue type

## Construction

- build to accommodate loading assembly
- Attention to detail: straight, symmetrical and perpendicular...to minimize unbalanced forces
- Base and top leveling ... minimizing unwanted unbalanced and angular forces
- Painted or coated wood
- Poor glue joints

## Transportation & Testing

- Tower packaging for protection and humidity
- Estimated load supported
- Students unfamiliar with test process, Load Block Assembly mounting
-

# Tower Template

- Template offered as a “starting point” for students new to the event
- Use of rather large balsawood members
- Teaches orientation for connecting sides with cross members
- Height: Div B @ ~50cm; Div C @ ~60cm
- Mass: Div B @ ~20gms; Div C @ ~25gms
- Div C template is similar to Div B template, except has a 6<sup>th</sup> layer to increase height to ~60cm
- Base: ~15cm square that is positioned 90<sup>0</sup> from 20x20cm opening (doesn't attempt the BONUS)

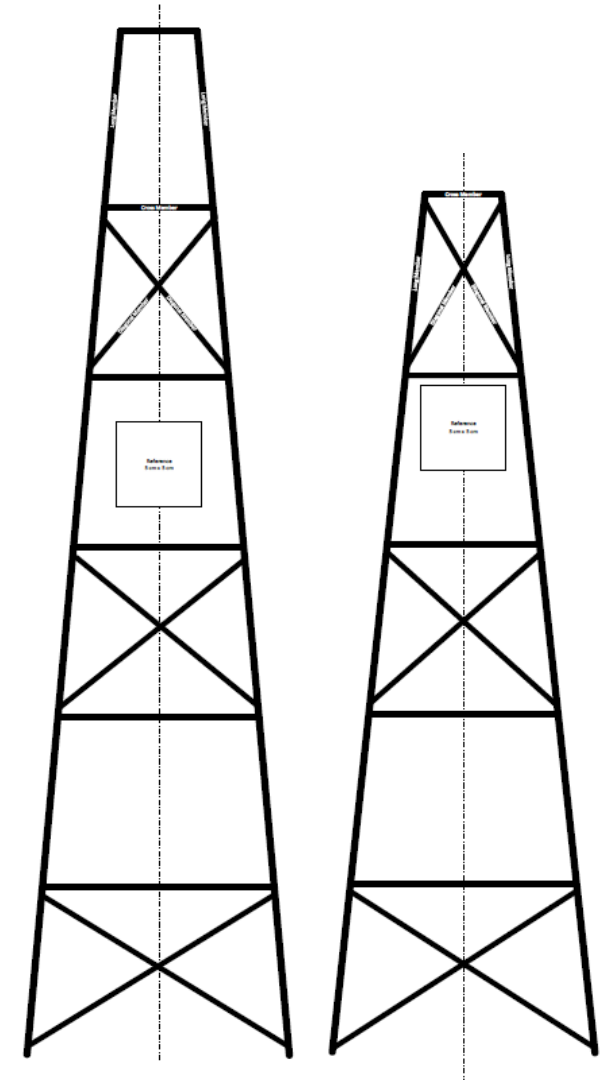



# Where to Start?

- Decide on a design... consider mimicking a “Real World” Tower, with alterations to meet Rules.
- Consider impacts of mounting load block assembly, loading sand, ...
- Consider materials and building techniques

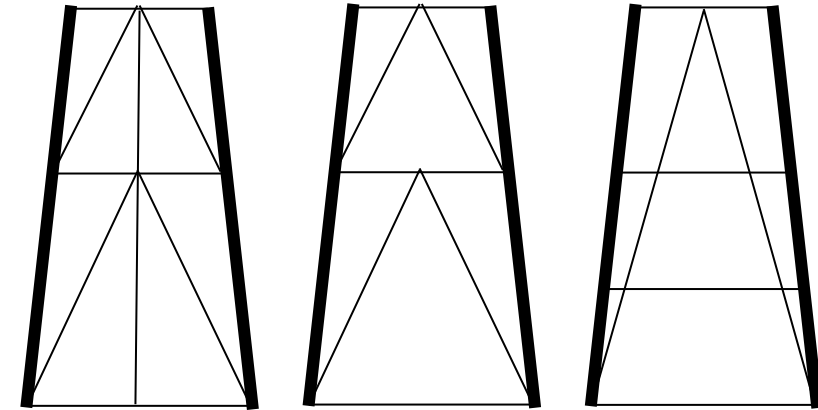

“V” Brace (also Inverted “V”)

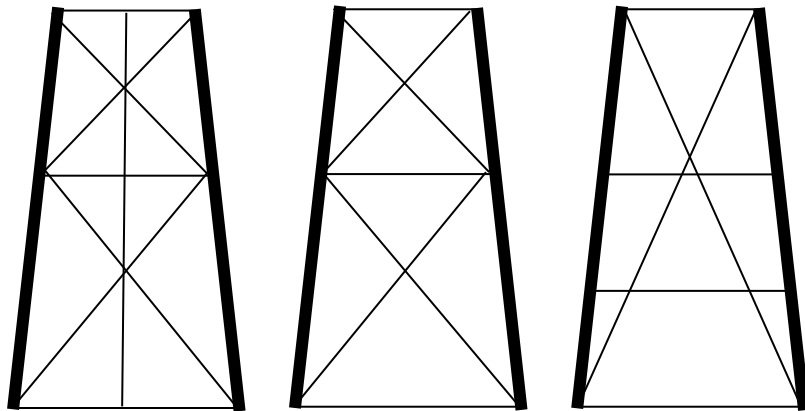

“X” Brace

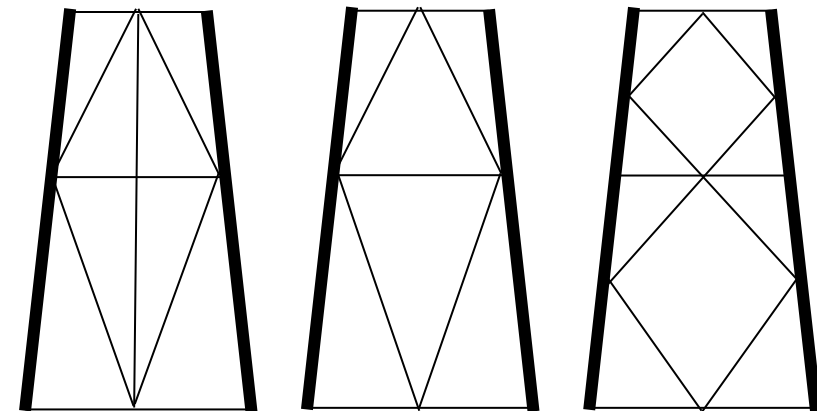

“Diamond” Brace

# Physics Behind the Structure

Example Loads (Statics)

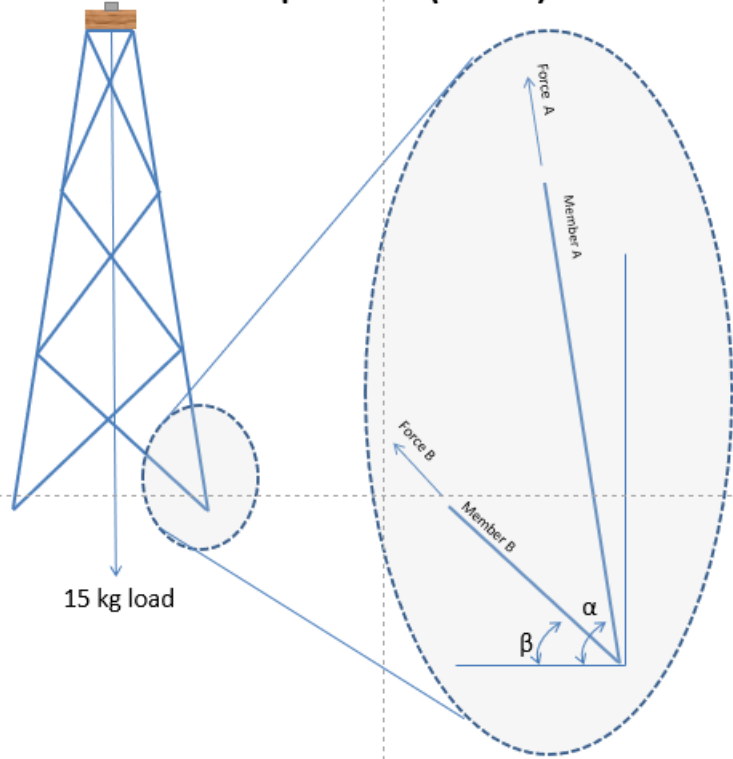

Force A\* = approx -4.7 kg (-10.3 lbf) [negative = Compression]  
 Force B\* = approx 1.3 kg (2.9 lbf) [Tension]

\* Assumes tower has 4 legs, each primary vertical leg is taking 1/4 of total load (15kg / 4 = 3.75 kg)  
 \* Assumes  $\alpha = 79$  degrees,  $\beta = 45$  degrees.

Example Loads Solved (Statics: Method of Sections)

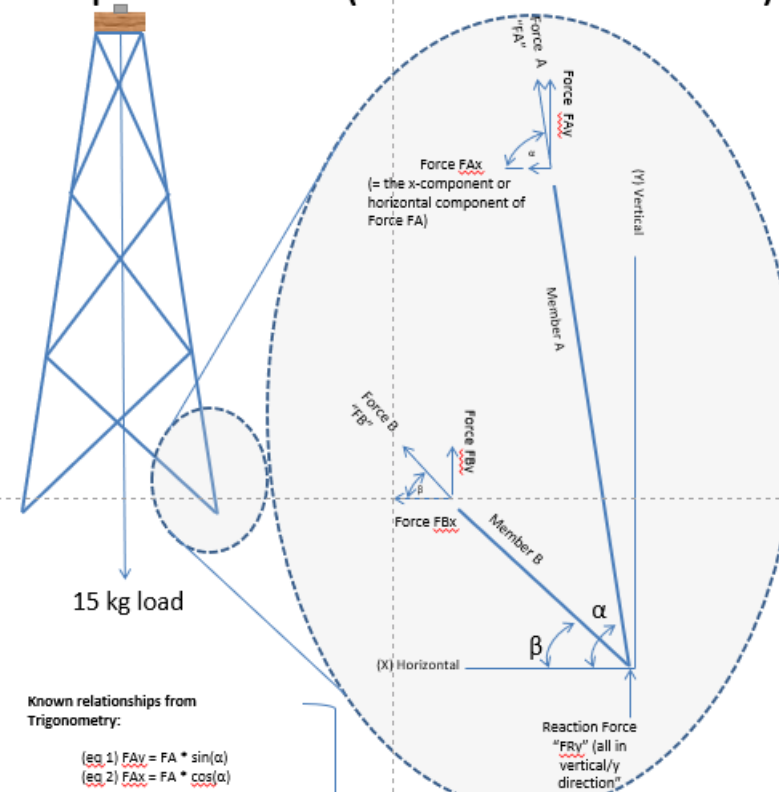

Known relationships from Trigonometry:

$$\begin{aligned} \text{(eq 1) } F_{Ay} &= F_A \cdot \sin(\alpha) \\ \text{(eq 2) } F_{Ax} &= F_A \cdot \cos(\alpha) \\ \text{(eq 3) } F_{Bv} &= F_B \cdot \sin(\beta) \\ \text{(eq 4) } F_{Bx} &= F_B \cdot \cos(\beta) \end{aligned}$$

Sum of the Forces in the X- and Y directions each equal 0 since it's not accelerating!

$$\begin{aligned} \text{(eq 5) } -F_{Ax} - F_{Bx} &= 0 \\ \text{(eq 6) } F_{Ay} + F_{Bv} + F_{Ry} &= 0 \end{aligned}$$

We have 6 equations and 6 unknowns (\*FRy,  $\alpha$ ,  $\beta$  are all known or measurable). Use some algebra and solve for the unknowns to find the forces in your members. Hint: just plug in FA and FB sides of Eq's 1-4 into eq's 5-6, then solve for FA or FB.

Sign Conventions: Per sketches above, Positive numbers = tension/pulling loads, negative = compression loads. (In summations, Positive x is to the right, Positive y is up)

\* Assuming tower has 4 legs, each primary vertical leg is taking 1/4 of total load (FRy = 15kg / 4 = 3.75 kgf)

Example Loads (Sensitivity to Angles!)

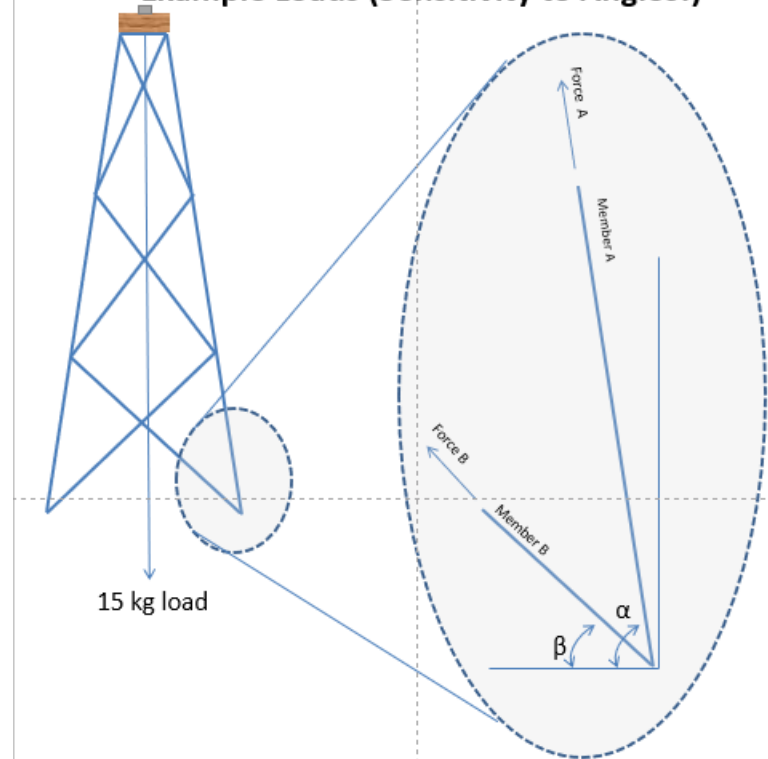

Total Load (Kgf)	Alpha (Deg)	Beta (Deg)	F Reaction y (FRy)	Member Forces (Kgf's; + is tension, - is compression)	
				FA	FB
15	79	45	3.75	-4.7	1.3
15	50	45	3.75	-30.4	27.7
15	60	45	3.75	-10.2	7.2
15	70	45	3.75	-6.3	3.0
15	80	45	3.75	-4.6	1.1
15	90	45	3.75	-3.8	0.0

Notice: Shallow angle alpha results in very high loads in member A and member B!

# Example Tower (Div B & Div C)

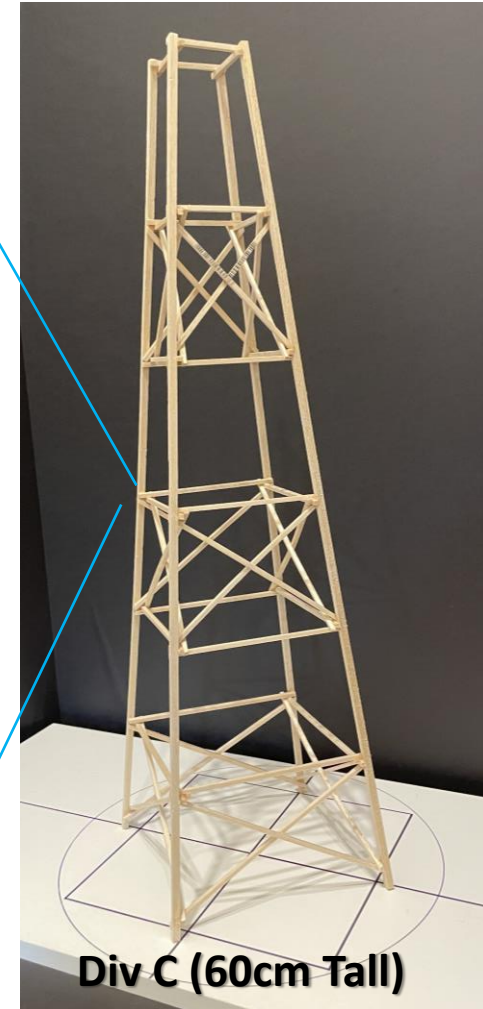
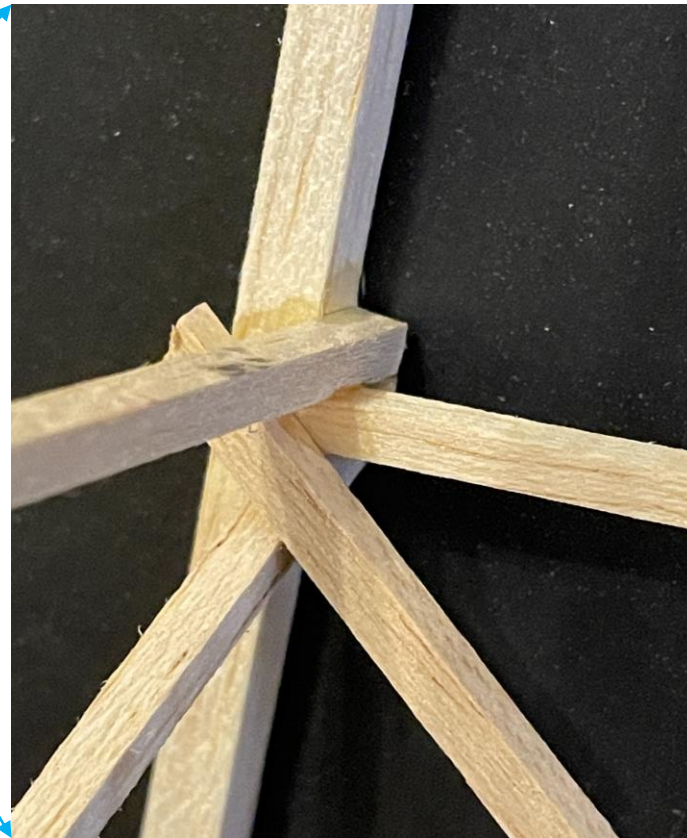
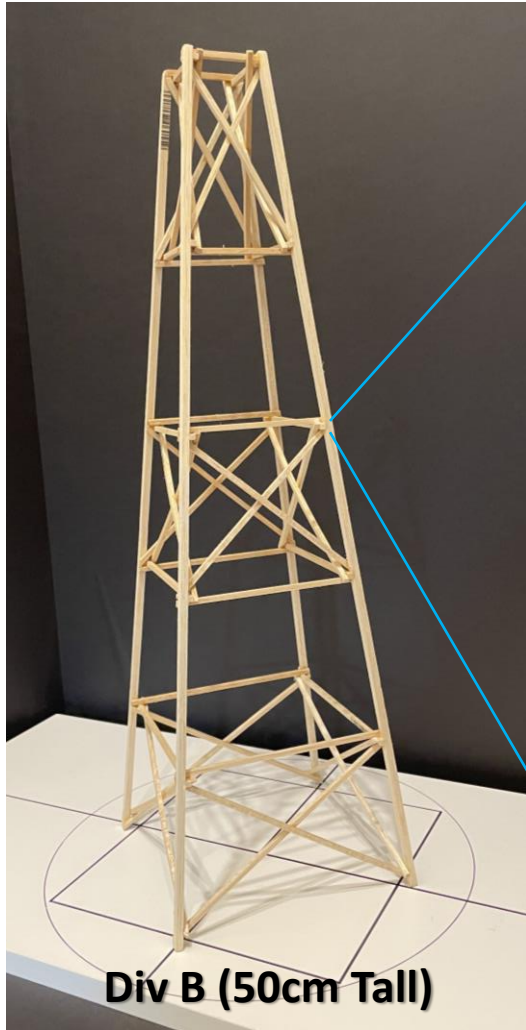

35cm Span

Keep Out

# Diagonals and Cross Bracing

- Diagonal Pieces & Cross Bracing are important!
  - Help prevent structure from torqueing or twisting
  - Adds additional strength
  - Adds additional weight
- If the Cross Braces cross, Glue them at the cross

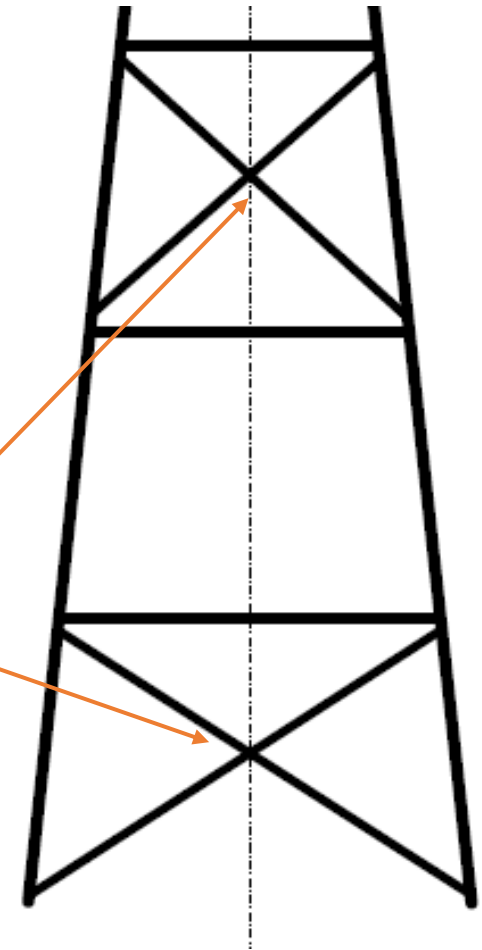

# Additional Considerations for Your Designs

- A. Member buckling (compression failures) of legs will be the predominant failure mode
- B. Load Block should not wobble and should also be level to ensure balanced loading of structure
- C. Tower Legs
  - Use higher density material
  - Match density, flexibility, grain color and patterns of all legs. Twisting of Tower can occur with mismatched vertical members
- D. Layer spacing is exponentially related to its ability to prevent legs from buckling (Euler “Oiler’s” Critical Load)
  - Shorter the spacing, the LESS the vertical member will be vulnerable to buckling
  - Longer the spacing, the MORE the vertical member will be vulnerable to buckling
- E. Cross Bracing is load bearing and typically in tension unless leg buckling occurs
- F. Imperfections can result in twisting which could cause Structure to fail under loading
- G. Hard tooling may be helpful in consistently and accurately positioning of members

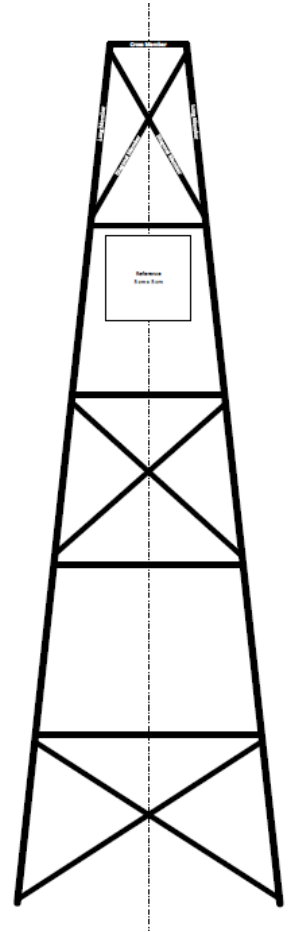



# What Will The Modeling Tell Me?

Experiment Quickly with Solvers after you understand the math!

Freeware:  
 Prof. Dr. Ing. A.  
 Valdivia, Jade  
 College  
 West Point Bridge  
 Designer;  
 SkyCIV Digital

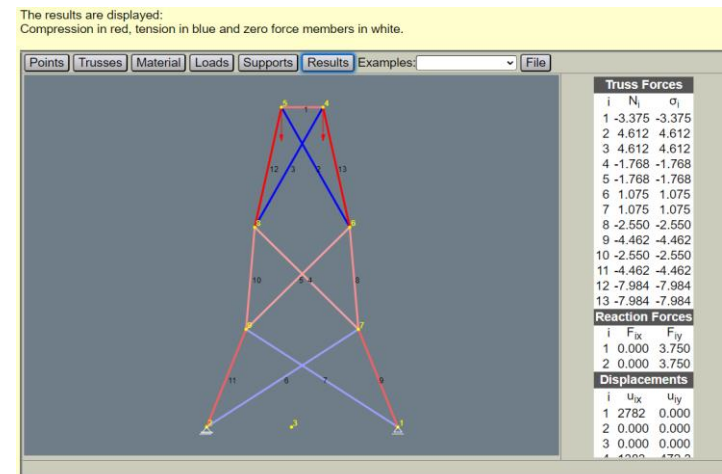
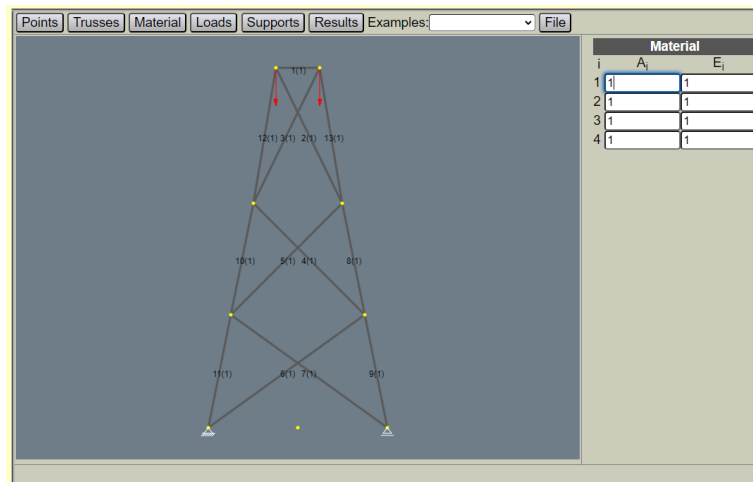
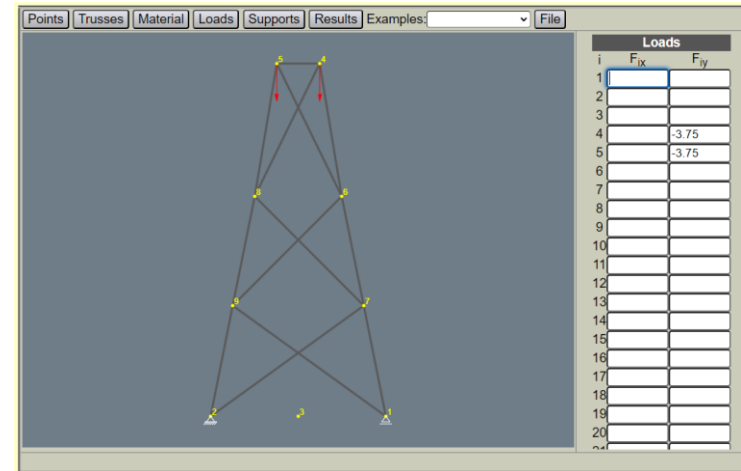
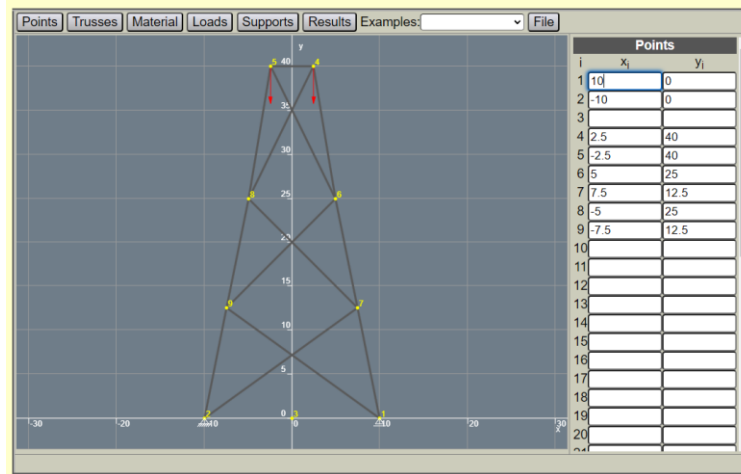

Source: [https://valdivia.staff.jade-hs.de/fachwerk\\_en.html](https://valdivia.staff.jade-hs.de/fachwerk_en.html)

# Wood

- Any type or size of wood may be used.
- Bamboo, grasses and paper **not wood**
- No limit on the cross-section size of individual pieces of wood or team made laminations.
- Check carefully for grain defects, cuts, chips or other damage
- Check wood pieces for consistency of density and stiffness... especially balsa.
- Consider laminating thin layers of wood to take advantage of multiple wood grains but remember glue is heavy...
- Use wood of higher density in compression applications

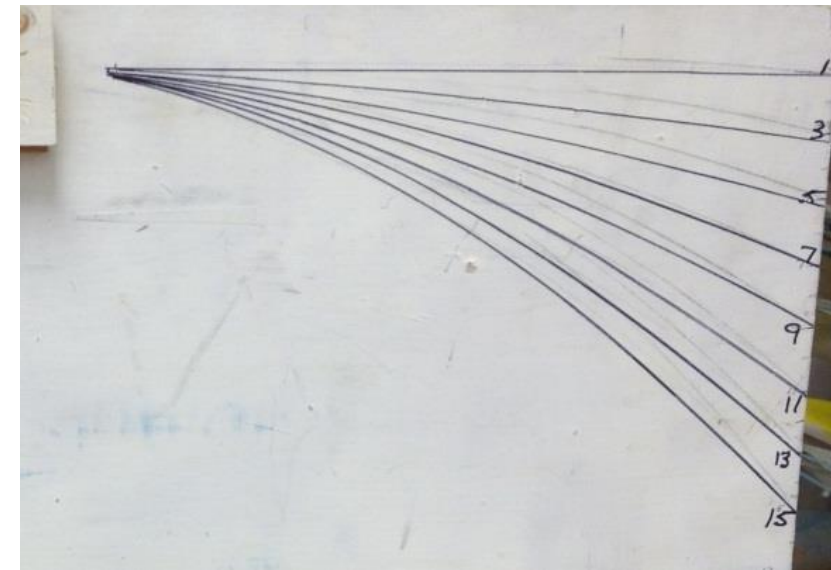
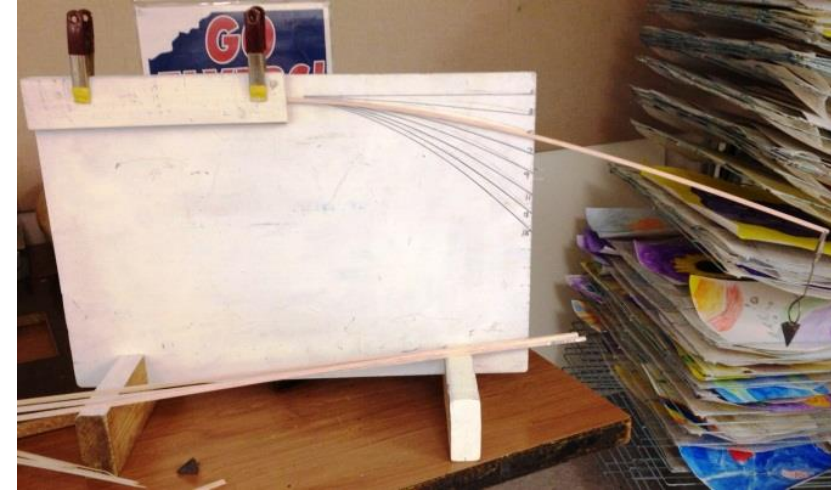

# Wood

Balsa; strongest wood, pound for pound!

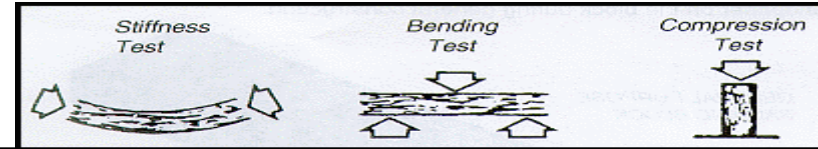

Species	Density (Lbs / cu Ft)	Stiffness	Bending	Compression
Balsa	8	72	70	75
Balsa	10	100	100	100
Balsa	14	156	161	149
Basswood	26	261	288	288
Pine, Spruce	28	230	260	289
Yellow Pine	28	222	277	288
Balsam Fir	30	241	291	341
Black Walnut	37	301	506	512
Oak	48	295	430	366
Hickory	50	379	638	514

**NOTE ABOUT CHART:** The strength of balsa varies in direct relation to its density or weight - the heavier the wood the stronger it is. The above chart was designed with 10 lb./cu. ft. balsa as the median. In other words, balsa at 10 lbs./cu. ft. has been tested given a value of 100. The other woods were then tested in the same way and given a figure that is **numerically in proportion**. By comparing the relative strength figures in the chart, it will be seen that balsa is as strong or stronger, pound for pound, than most of the species shown.

From: **SIG MANUFACTURING'S INTERESTING FACTS ABOUT BALSA WOOD** <http://www.go-cl.se/balsa.html>

# Adhesives

3.h.iii Any commercially available adhesive may be used.



GLUE OPTIONS	Polyvinyl Acetate	Polyurethane	Epoxy	Cyanoacrylate
Shear Strength (psi)	3,600	3,500	2,000	3,000
Open Time / Clamp Time (Minutes)	10 / 60	10 / 120	15 / 45	1 / 1
Notes	Water based, will not fill gaps. Can be diluted	Needs moisture to cure	Does not shrink	Sets Quickly
Cost (\$/oz) (more stars, higher cost)	★	★★	★★★★	★★★★★
Brands	Titebond Original, Elmer's Carpenter's, Tacky Formula Modeling Glue	Gorilla, Elmer's Probond, Titebond, ExcelOne	System Three T-88, Industrial G-1	Gorilla Super, Krazy glue, Super 'T', Permabond

\*PPE = Personal Protective Equipment

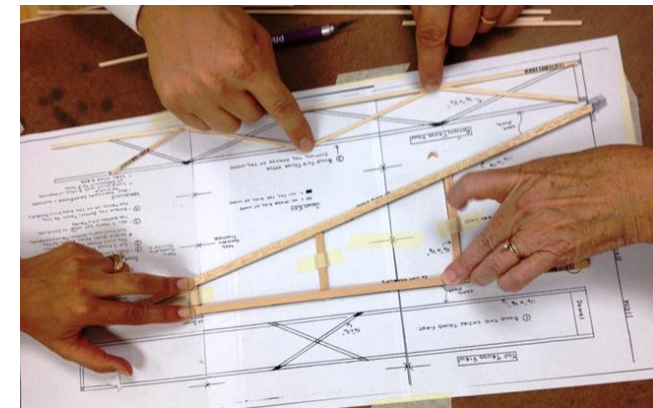

# Adhesives

- Read the Material Safety Data Sheet (MSDS)...Safety First
- Choice...not critical from a strength point of view. Wood shear parallel to grain is less than 2,000 psi for common woods, most glues above 2,000 psi.
- Experts should consider Wood Glue - Dilute with water or rubbing alcohol (1:1); Longer to dry but doesn't make the wood brittle; More flexible, moves with the wood
- Super Glue with Accelerator – quick but can dry out the wood; Rigid when dry
- Do not recommend: Silicone or Hot Melt
- Use your Adhesive modestly! . . . It is heavy! **If you can see it, you have used too much**
- Adhesive shelf life is typically only a year or two...use fresh Adhesive
- Use of Adhesives
  - Clean, dry, dust free surfaces!
  - Maximize surface area
  - “wet” both surfaces with glue and then assemble.
  - Normally need to “clamp joint” for best bond and air elimination
  - Glue at 65° F or higher typically



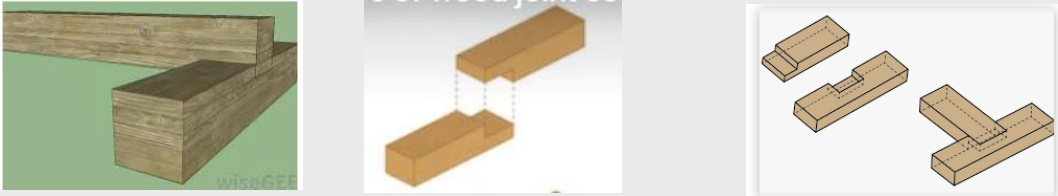
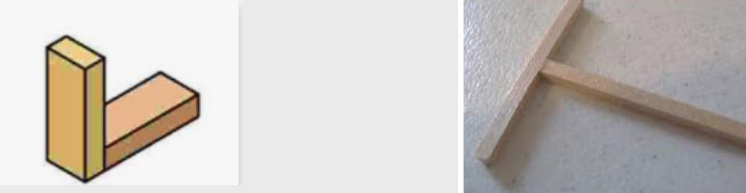
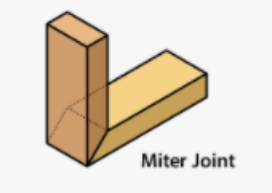

# Basic Wood Joints

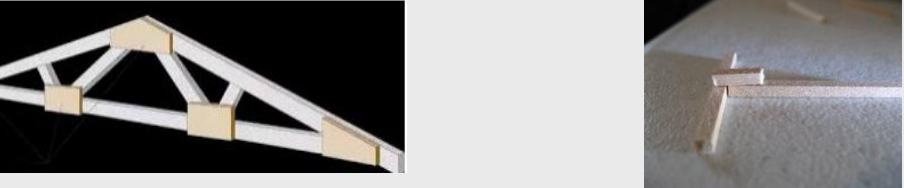
<p><b>Lap</b></p>	<p>One of the strongest; Use as often as possible Strengthens compression pieces by adding stiffness Flaw – only as strong as the face of the wood!</p>	
<p><b>Butt</b></p>	<p>Not strong for tension members; Under Tension will pull apart; Under Compression will stay together</p>	
<p><b>Miter</b></p>	<p>Usually, two 45-degree angle pieces joined to form a 90-degree angle</p>	 <p>Miter Joint</p>
<p><b>Notch</b></p>	<p>Stronger than Butt Joint; Less strength than a Lap Joint; Difficult to build; May damage wood integrity</p>	
<p><b>Gusset</b></p>	<p>Combine a Butt Joint with a Lap Joint &amp; Lap another piece of wood at the joint - Strong in both tension and compression</p>	

# Examples of Good Bonding



**If you can see the glue, then you've probably used too much!**

# Building Tools (1 of 2)

- Wood
  - Your Choice: Very Light Structures Use Balsawood; Some Use Bass Wood For Ease Of Construction
  - Get Individual Piece Parts At Hobby Shops, Ace Hardware, Or Order Special Bundles To Your Needs [Midwest Products Co., Inc (800) 348-3497 or [Midwest Products.com](http://MidwestProducts.com)]
- Metric Ruler at least 450mm Long, Metal Seems To Work Well
- Glue: Wood Glues Will Work, But “Gap Filing” (Jell Induced) Crazy Glue (Cyanoacrylate): 5-10 sec Cure Works Very Well **(Be Careful No To Glue Fingers!)**
- Cutting Tools
  - Razor Blades or Exacto® Knife **(Be Careful – Very Sharp!)**
  - Dremel® Tool Works Well For Trimming **(Be Careful – Some Tools are Dangerous!)**
- Holding Devices: Pins, Clips, and/or Clamps **(Careful Not To Damage Wood)**
- Sand Paper (P2000 Very Fine Grains)
- Flat Work Surface - Portion Of A Drop Ceiling Panel With Taped The Edges, And Staple Graph Paper To Surface



# Building Tools (2 of 2)

- A. Support Blocks (confirms bridge-to-base mounting compliance)
- B. Extra Load Blocks (alignment aide)
- C. Positioning Blocks (used to space trusses and ensure perpendicularity)
- D. Tape (substitute for clamps or clips)
- E. Pre-cut Alignment Blocks (alignment aides; various sizes)
- F. Nail files (instead of Razorblade cutting)
- G. Exacto® “saw” blade (instead of Razorblade cutting)
- H. Pencil (used to hold bonded members so not to glue your fingers)
- I. Aluminum Guide strips (alignment aides)
- J. Cutting Board (free tile sample from Home Depot)
- K. Scale Base Offset Device (Dairy Queen Cup; place on small scale base, and tare; holds larger bridge on small scale’s base surface)
- L. Razor Blade Holder (mitigates accidental cuts; found @ Ace Hardware)
- M. Various Bubble Levels (levels test stand and confirms load block level on Bridge)
- N. US Nickels (used as a scale check as new Nickel weighs ~5.1g each)

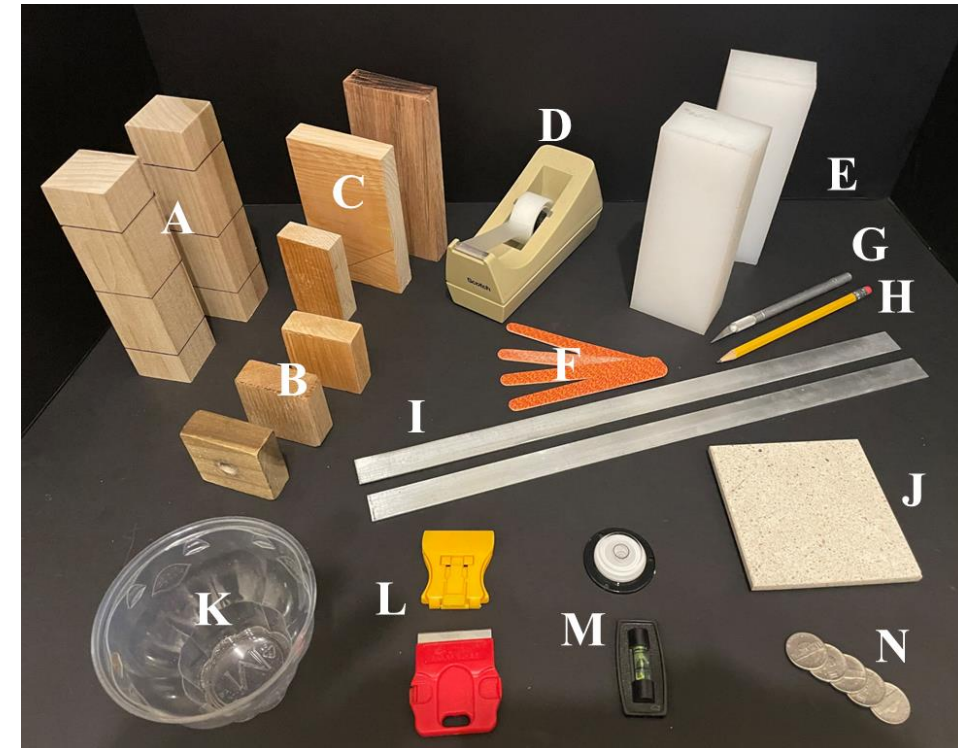



# Building Tips - Focus Areas

- Understand ALL design requirements stated in the rules!
- Place design on paper
  - Design to scale, use graph/grid paper
  - Draw the thickness of the wood pieces
  - Same shape on all sides
  - Evaluate design against rules
  - Hint: bigger is better for beginners than starting off too small
  - Attach design to foam board, cover with wax paper
- Carefully build!
  - Pay attention to the “details”, measure twice, cut once
  - Make bonding surfaces smooth and flat
  - Perpendicularity & symmetry are very important
  - Maximize bonding (glue) area
  - Use smooth surfaces, gussets, miter joints, other reinforcing methods

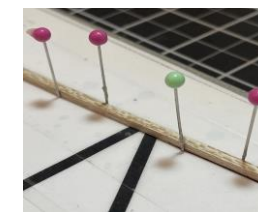
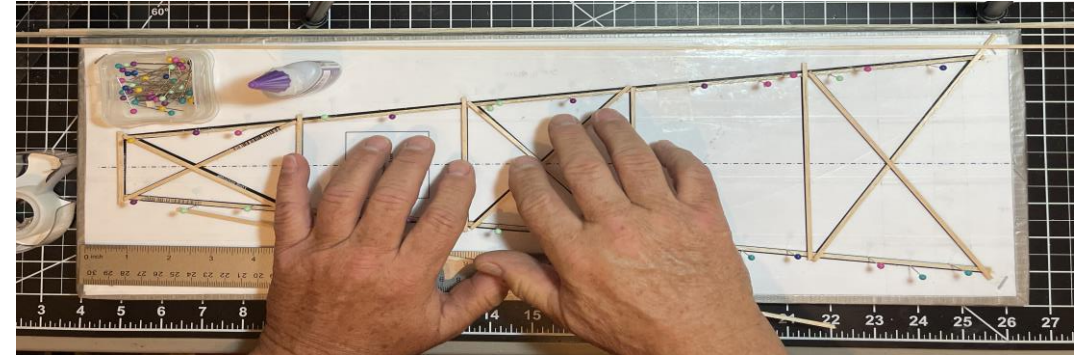

# Check Your Tower!

- Trim all the excess/unnecessary wood
- Visually inspect that bond joints look good
- Check mass of tower (if you used the Div. B template it should be ~20 g)
- Make sure the base is stable (not wobbling); Make sure the Top is stable (not wobbling); Make sure the Structure is level. Check height!
- Div. B template design should hold the full 15Kg load. If not, then examine the wood pieces to determine root cause, and rebuild with more attention to material selections and better bonding techniques to build a Structure that holds the full load.





# Beginners - Testing the Div B Template

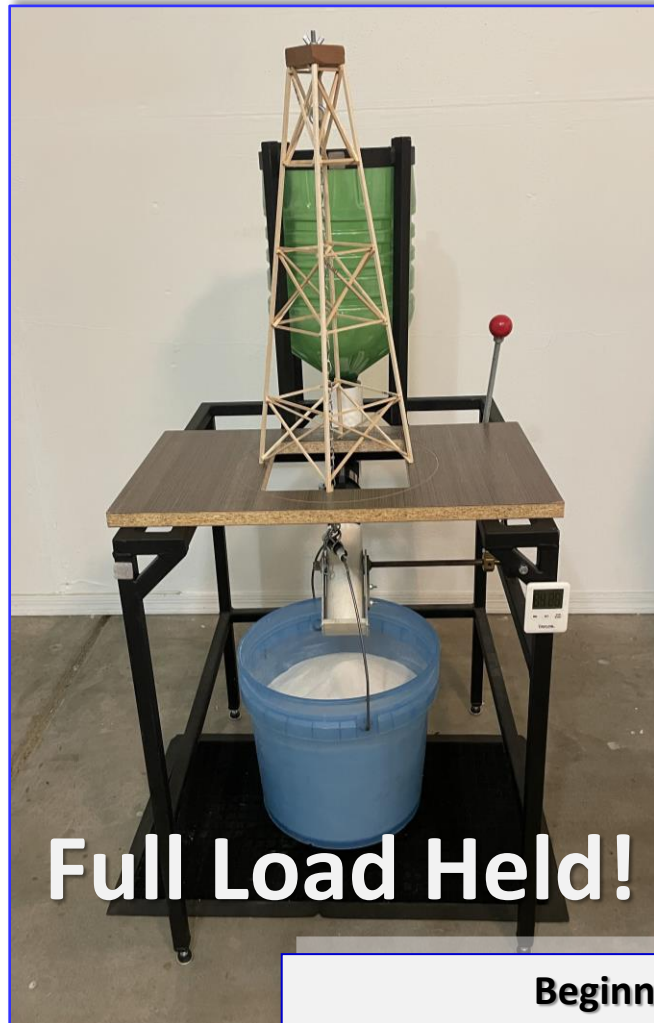

## • **RESULTS:**

- Tier 1 (Materials, Construction, dimensions, valid test)
- Tower Mass = 20.48gms
- Load Held = 15kg (max Load)
- Score =  $15,000\text{g} / 20.48\text{gms} = 732$
- No Bonus added to score
- Final Score = **732 Tier 1**

Beginner Students Should Be Able to Build Template and Hold Full Load

# Next Steps - Enhancing the Div B Template Design

- Decrease wood member dimension to next smaller sized pieces
  - Vertical Members = 1/8" x 1/8"
  - Cross Support Members = 3/16" x 3/16"
- Added Cross Support members to Level #2 and #4 (now has support members at all 5 levels)
- Focus on Reducing Structure Mass
  - Mass of Tower should decrease by ~7gms from ~20 gms to ~13 gms
- Test and observe initial failure mode, if any
- Master building skills until hold full load with this design, then move onto more complex designs.



## RESULTS:

- Tier 1 (Materials, Construction, dimensions, valid test)
- Tower Mass = 13.04gms
- Load Held = 15,000g (Max Load!)
- Score = 15,000g / 13.04gms = 1150 (previous design score = 732 Tier1)
- No Bonus added to score
- Final Score = **1150 Tier 1**

**WHAT DESIGN CHANGES WOULD YOU TRY NEXT, & Why?**

**See example Design Log that captured findings/improvements**

# Fault Diagnosis Capabilities

- 3<sup>rd</sup> Tower Test: Purposefully built with reduction in members to demonstrate Fault Diagnosis efforts
  - Design is vulnerable to twisting
  - Expect compression failure on vertical support legs
- Use Smart Phones to record “slow motion” video for entire loading of Structure
  - Extract video just prior to break (from second before break, to second after break)
- View frame-by-frame edited video till 1<sup>st</sup> failure is identified
  - “frame grab” to get photo of 1<sup>st</sup> break
  - NOTE: May want to re-save edited video into MP4 format by using App for the conversion (usually captured in MOV format)
- Failure diagnosis is a critical skill in identifying weak points in design during load testing, to determining design improvements for better structures

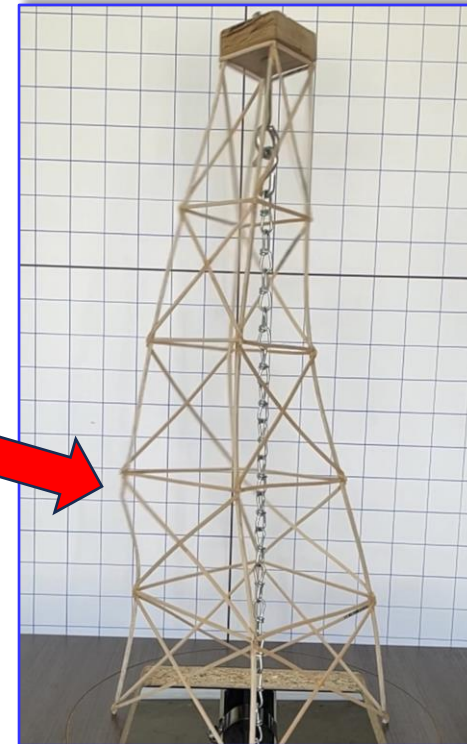

## RESULTS:

- Tier 1 (Materials, Construction, dimensions, valid test)
- Tower Mass = 10.05gms
- Load Held = 5,420g
- Score =  $5,420g / 10.05gms = 539$
- No Bonus added to score
- Final Score = **539 Tier 1**

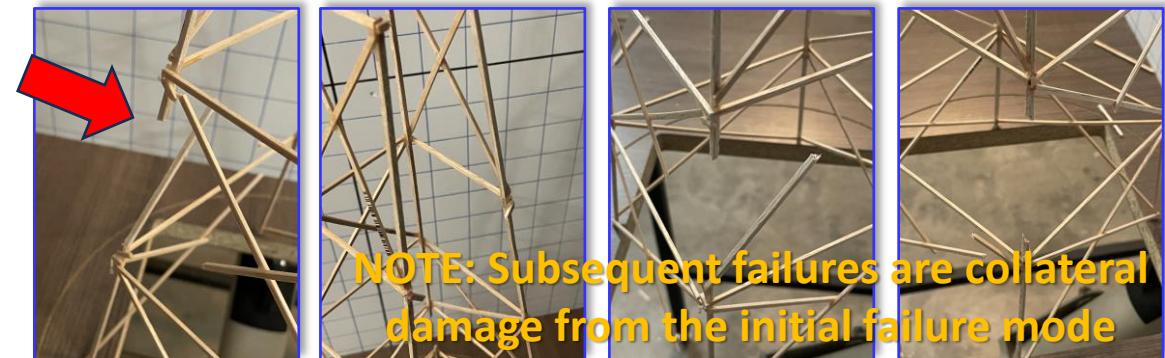



# Always Diagnose Failures & Determination Root Cause

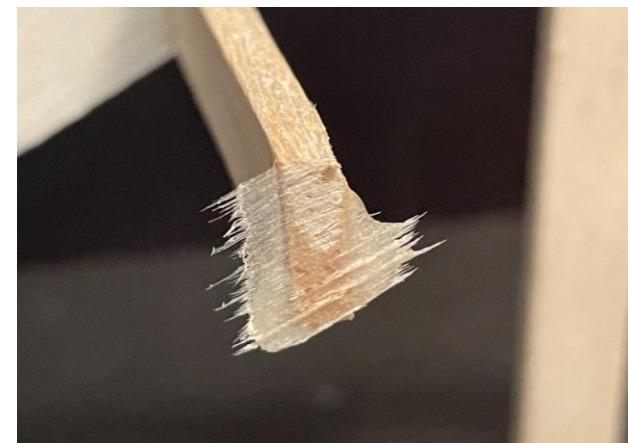
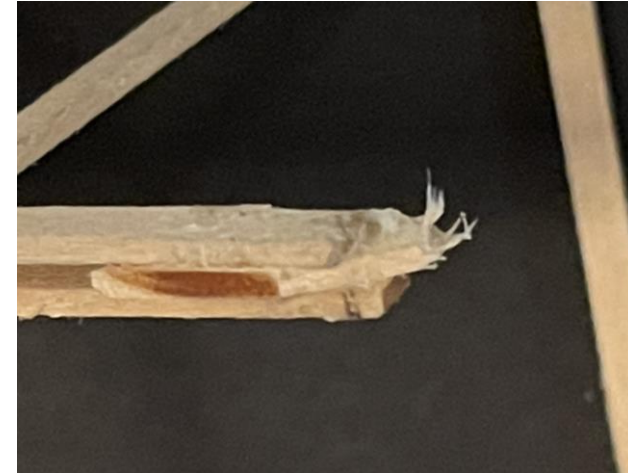

**Review Post-test Artifacts. Are there Bond Failures and/or Wood Failures?**

# Storage and Transportation

Potential assignment for an eager Parent?



Cardboard box with Styrofoam packing peanuts works great! (Shown with Elevated Bridges)



The ultimate in transport boxes, wooden box with carrying handle for a tower!! Includes a space for the tower and protective eye gear (Cover not shown)

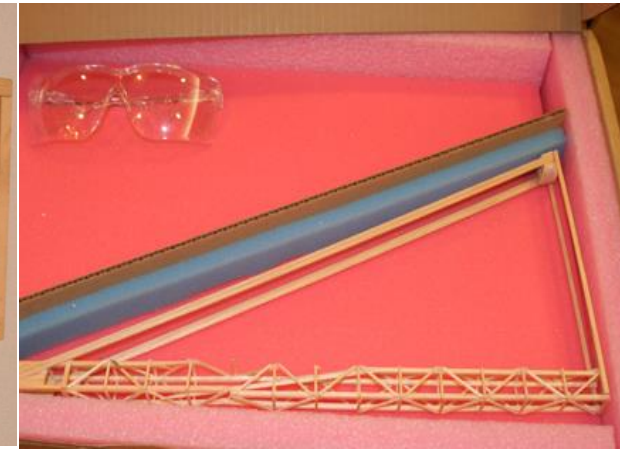

Foam lined box used for a boomilever

# Closing Comments

- A. Recommend “compliant” Test Stand and have the “proper” scales for pre-event testing.
- B. Encourage student’s self-learning with plans for many build and test activities
- C. Teams should come prepared to ask Event Supervisors for guidance at Invitationals and Regionals, ... to help with the learning and suggestions for next steps.
- D. Balsa wood has a wide range of performance so have Students pay attention to wood quality and grains, and density for pairing purposes.